



UNI-ROYAL
厚聲集團

DATA SHEET

Product Name Thick Film Chip Resistor Network

Part Name 10P8/10S8/10T8/10E9/8R06/8S06 Series

File No. SMD-SP-025

Uniroyal Electronics Global Co., Ltd.

88#, Longteng Road, Economic & Technical Development Zone, Kunshan, Jiangsu, China

Tel +86 512 5763 1411 / 22 /33

Email marketing@uni-royal.cn

Manufacture Plant Uniroyal Electronics Industry Co., Ltd.

Aeon Technology Corporation

Royal Electronic Factory (Thailand) Co., Ltd.

Royal Technology (Thailand) Co., Ltd.

1. Scope

- 1.1 This datasheet is the characteristics of Thick Film Chip Resistor Network manufactured by UNI-ROYAL.
- 1.2 High density, more than 1 resistors in one small case
- 1.3 Tape/Reel packaging is suitable for automatic placement machine
- 1.4 Superior solderability

2. Part No. System

Part No. includes 14 codes shown as below:

- 2.1 1st~4th codes: Part name. E.g.: 10P8/10S8/10T8/10E9/8R06/8S06
- 2.2 5th~6th codes: Power rating.

Wattage	1/32	1/16
Normal Size	WH	WG

2.3 7th code: Tolerance. E.g.: F=±1% J=±5%

2.4 8th~11th codes: Resistance Value.

2.4.1 If value belongs to standard value of E-24 series, the 8th code is zero, 9th~10th codes are the significant figures of resistance value, and the 11th code is the power of ten.

2.4.2 If value belongs to standard value of E-96 series, the 8th~10th codes are the significant figures of resistance value, and the 11th code is the power of ten.

2.4.3 11th codes listed as following:

$$0=10^0 \quad 1=10^1 \quad 2=10^2 \quad 3=10^3 \quad 4=10^4 \quad 5=10^5 \quad 6=10^6 \quad J=10^{-1} \quad K=10^{-2} \quad L=10^{-3} \quad M=10^{-4}$$

2.5 12th~14th codes.

2.5.1 12th code: Packaging Type. E.g.: T=Tape/Reel

2.5.2 13th code: Standard Packing Quantity.

$$4=4,000\text{pcs} \quad 5=5,000\text{pcs}$$

2.5.3 14th code: Special features.

E = Environmental Protection, Lead Free, or Standard type.

3. Ordering Procedure

(Example: 10P8 1/32W ±5% 56K Ω T/R-5000)

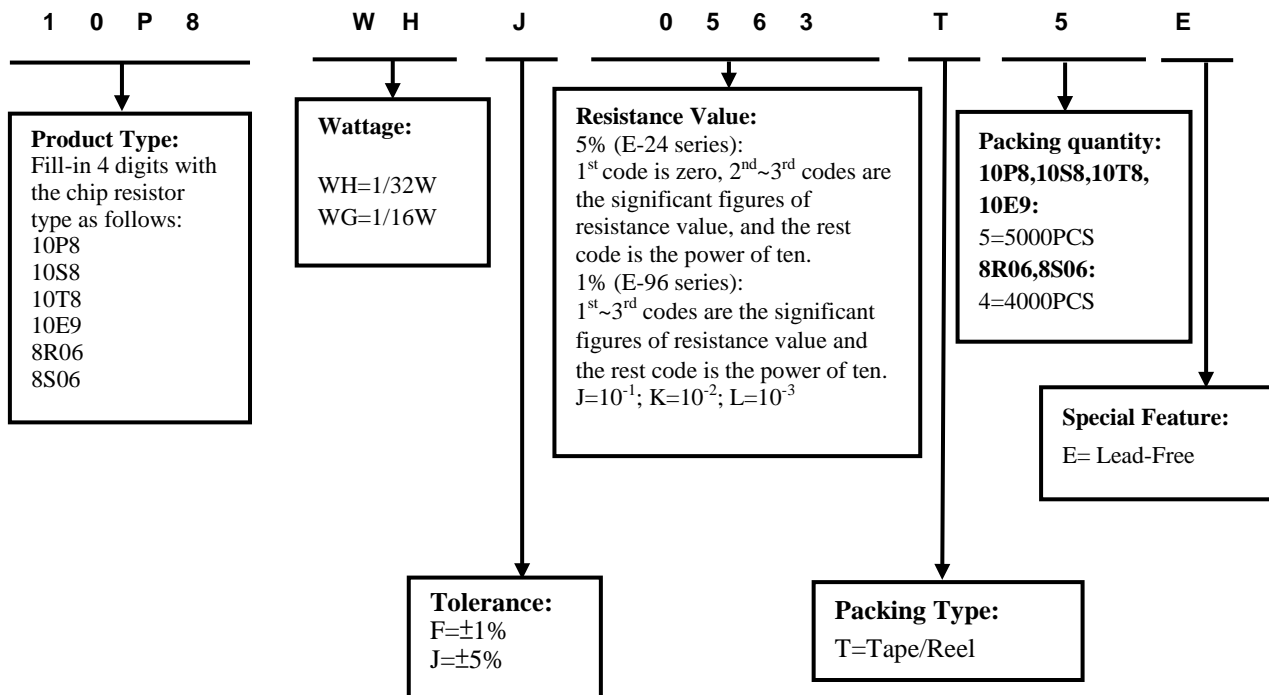

4. **Marking**

4.1 ±5% Tolerance of 10P8 size: the first two digits are significant figures of resistance and the third denotes number of zeros following
 Example:

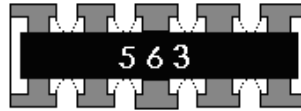

563 → 56KΩ

4.2 ±1% Tolerance of 10P8 size: first three digits are significant figures of resistance and the fourth denotes number of zeros following
 Example:



2372 → 23.7KΩ

4.3 ±5% Tolerance of 10S8 size: the first two digits are significant figures of resistance and the third denotes number of zeros following
 Example:

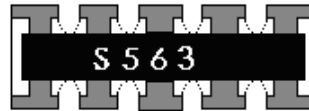

S563 → 56KΩ

4.4 ±1% Tolerance of 10S8 size: first three digits are significant figures of resistance and the fourth denotes number of zeros following
 Example:



S2372 → 23.7KΩ

4.5 ±5% Tolerance of 10E9 size: the first two digits are significant figures of resistance and the third denotes number of zeros following, The public end location is the location of the white dots.
 Example:

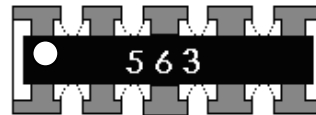

563 → 56KΩ

4.6 ±1% Tolerance of 10E9 size: first three digits are significant figures of resistance and the fourth denotes number of zeros following, The public end location is the location of the white dots.
 Example:



2372 → 23.7KΩ

4.7 ±5% Tolerance of 10T8 size: the first two digits are significant figures of resistance and the third denotes number of zeros following, The public end location is the location of the white frame.
 Example:



563 → 56KΩ

4.8 ±1% Tolerance of 10T8 size: first three digits are significant figures of resistance and the fourth denotes number of zeros following, The public end location is the location of the white frame.
 Example:



2372 → 23.7KΩ

4.9 ±5% Tolerance of 8R06 size: the first two digits are significant figures of resistance and the third denotes number of zeros following
 Example:

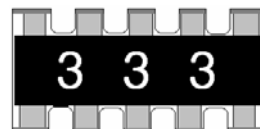

333 → 33KΩ

4.10 ±1% Tolerance of 8R06 size: first three digits are significant figures of resistance and the fourth denotes number of zeros following
 Example:

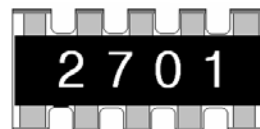

2701 → 2.7KΩ

4.11 ±5% Tolerance of 8S06 size: the first two digits are significant figures of resistance and the third denotes number of zeros following
 Example:

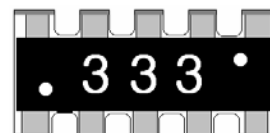

333 → 33KΩ

4. $12 \pm 1\%$ Tolerance of 8S06 size: first three digits are significant figures of resistance and the fourth denotes number of zeros following
 Example:

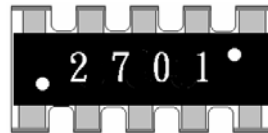

2701 → 2.7KΩ

5. Dimension & Equivalent Circuit Diagram

5.1 Equivalent Circuit Diagram:

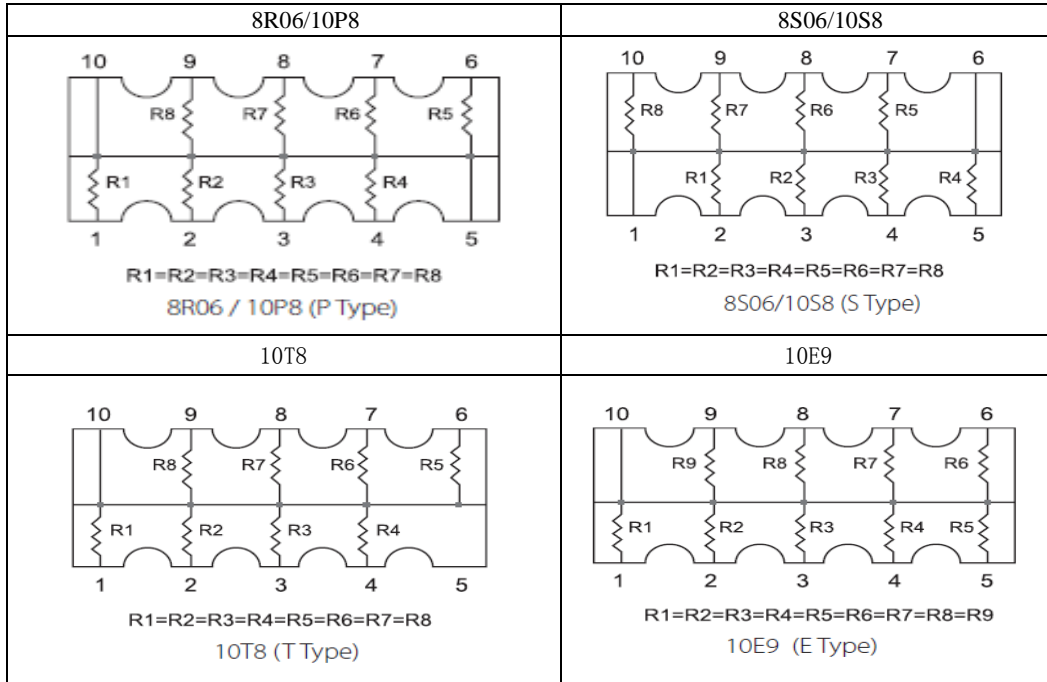

5.2 Dimensions in mm:

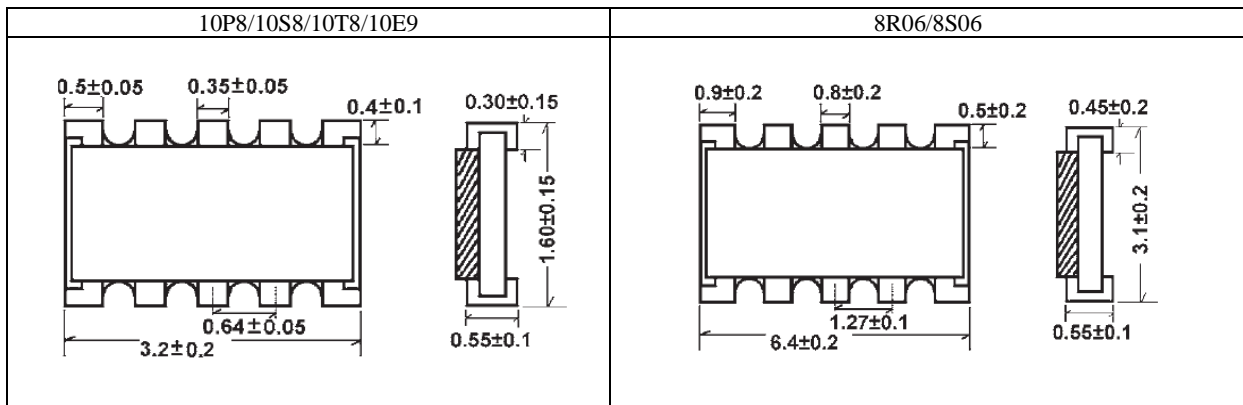

6. Resistance Range

Type	Rated power	Max Working Voltage	Max Overload Voltage	Dielectric Withstanding Voltage	Resistance Range $\pm 5\% \pm 1\%$	Operating Temperature	Resistance Value of Jumper	Rated Current of Jumper
10P8 10S8 10T8 10E9	1/32W (1/16W special provide)	25V	50V	50V	$10 \Omega \sim 1M \Omega$	$-55^\circ C \sim +155^\circ C$	<50mΩ	0.5A
8R06 8S06	1/16W	50V	100V	100V	$\pm 1\%: 30 \Omega \sim 1M \Omega$ $\pm 5\%: 10 \Omega \sim 1M \Omega$	$-55^\circ C \sim +155^\circ C$	/	/

7. Soldering pad size recommended

Type	Dimension(mm)				
	A	B	W	C	P1
10P8					
10S8					
10T8	0.8±0.1	0.35±0.05	2.6±0.2	0.29±0.05	0.64±0.05
10E9					
8R06	2.1±0.1	0.6±0.1	4.1±0.1	/	1.27±0.1
8S06					

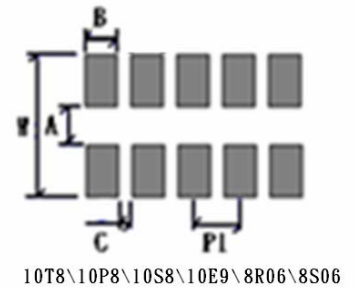

8. Derating Curve

Power rating will change based on continuous load at ambient temperature from -55 to 155°C. It is constant between -55 to 70°C, and derate to zero when temperature rise from 70 to 155°C.

Voltage rating:

Resistors shall have a rated direct-current (DC) continuous working voltage or an approximate sine-wave root-mean-square (RMS) alternating-current (AC) continuous working voltage at commercial-line frequency and waveform corresponding to the power rating, as determined from the following formula:

$$RCWV = \sqrt{P \times R}$$

Remark: RCWV: Rating Continuous Working Voltage (Volt.) P: power rating (Watt) R: nominal resistance (Ω)

In no case shall the rated DC or RMS AC continuous working voltage be greater than the applicable maximum value.

The overload voltage is 2.5 times RCWV or Max. Overload voltage whichever is lower.

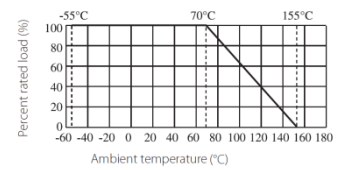

9. Structure

10P8/10S8/10T8/10E9

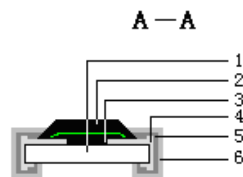
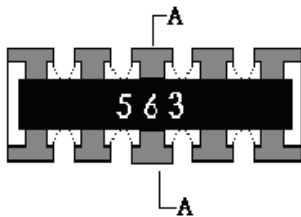

- 1: High purity alumina substrate (96%AL₂O₃、0.3±0.1%CaO、1.0±0.3%MgO、2.1±0.05%SiO₂)
- 2: Protective covering
- 3: Resistive covering
- 4: Termination (inner) Ag/Pd
- 5: Termination (between) Ni plating
- 6: Termination (outer) Sn plating

8R06/8S06

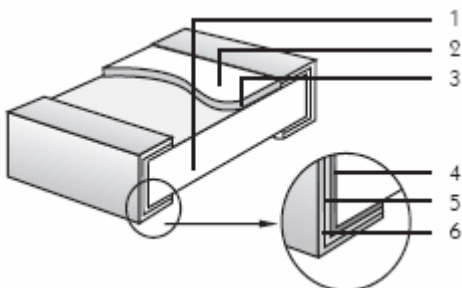

- 1: High purity alumina substrate (96%AL₂O₃)
- 2: Protective covering
- 3: Resistive covering (Ag for 0Ω)
- 4: Termination (inner) Ag/Pd
- 5: Termination (between) Ni plating
- 6: Termination (outer) Sn plating

10. Performance Specification

Characteristic	Limits	Test Methods (GB/T5729&JIS-C-5201&IEC60115-1)
Temperature Coefficient	±200PPM/°C	4.8 Natural resistance changes per temp. Degree centigrade $\frac{R_2 - R_1}{R_1(t_2 - t_1)} \times 10^6 \text{ (PPM/°C)}$ R ₁ : Resistance Value at room temperature (t ₁) ; R ₂ : Resistance at test temperature (t ₂) t ₁ : +25°C or specified room temperature t ₂ : Test temperature (-55°C or 125°C)
Short-time overload	±(2.0%+0.05Ω)	4.13 Permanent resistance change after the application of a potential of 2.5 times RCWV of Max. Overload Voltage whichever less for 5 seconds.
Insulation resistance	≥1,000 MΩ	4.6 The measuring voltage shall be ,measured with a direct voltage of (100±15)V or a voltage equal to the dielectric withstanding voltage., and apply for 1min.
Dielectric withstanding voltage	No evidence of flashover mechanical damage, arcing or insulation breaks down.	4.7 Resistors shall be clamped in the trough of a 90° metallic v-block and shall be tested at ac potential respectively specified in the given list of each product type for 60-70 seconds.
Terminal bending	±(1.0%+0.05Ω)	4.33 Twist of test board: Y/x = 3/90 mm for 60Seconds
Soldering heat	Resistance change rate is: ±(1.0%+0.05Ω)	4.18 Dip the resistor into a solder bath having a temperature of 260°C±5°C and hold it for 10±1 seconds.
Solderability	Coverage must be over 95%.	4.17 The area covered with a new, smooth, clean, shiny and continuous surface free from concentrated pinholes. Temperature of solder:245±3°C; Dwell time in solder: 2~3 seconds.
Load life in humidity	±(3.0%+0.1Ω)	7.9 Resistance change after 1,000 hours (1.5 hours “ON”, 0.5 hour “OFF”) at RCWV in a humidity chamber controlled at 40°C±2°C and 90 to 95% relative humidity.
Load life	±(3.0%+0.1Ω)	4.25.1 Permanent resistance change after 1,000 hours operating at RCWV with duty cycle 1.5 hours “ON”, 0.5 hour “OFF” at 70°C±2°C ambient.
Low Temperature Storage	±(3.0%+0.1Ω)	IEC 60068-2-1 (Aa) Lower limit temperature , for 2H.
High Temperature Exposure	±(3.0%+0.1Ω)	MIL-STD-202 108A Upper limit temperature , for 1000H.
Leaching	No visible damage	J-STD-002 Test D Samples completely immersed for 30 sec in solder bath at 260°C
Rapid change of temperature	±(3.0%+0.1Ω)	4.19 30 min at lower limit temperature and 30 min at upper limit temperature , 100 cycles.

11. Soldering Condition

(This is for recommendation, please customer perform adjustment according to actual application)

11.1 Recommend Reflow Soldering Profile : (solder : Sn96.5 / Ag3 / Cu0.5)

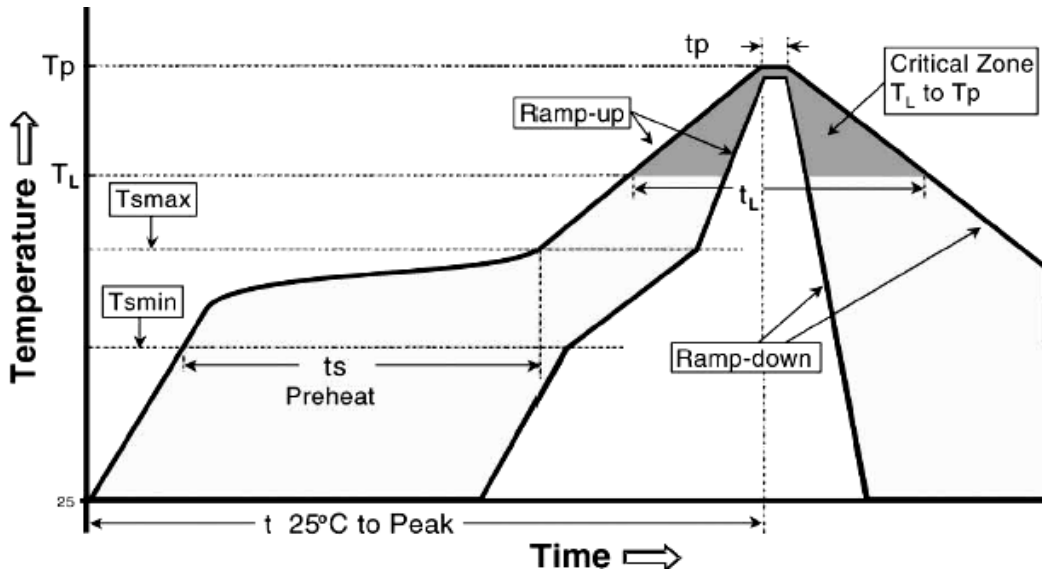

Profile Feature	Lead (Pb)-Free solder
Preheat: Temperature Min ($T_{s_{min}}$) Temperature Max ($T_{s_{max}}$) Time ($T_{s_{min}}$ to $T_{s_{max}}$) (t_s)	150°C 200°C 60 -120 seconds
Average ramp-up rate: ($T_{s_{max}}$ to T_p)	3°C / second max.
Time maintained above : Temperature (T_L) Time (t_L)	217°C 60-150 seconds
Peak Temperature (T_p)	260°C
Time within $+0^{\circ}\text{C}$ to -5°C of actual peak Temperature (t_p) ²	10 seconds
Ramp-down Rate	6°C/second max.
Time 25°C to Peak Temperature	8minutes max.

Allowed Re-flow times : 2 times

Remark : To avoid discoloration phenomena of chip on terminal electrodes, please use N2 Re-flow furnace .

11.2 Recommend Wave Soldering Profile : (Apply to 0603 and above size)

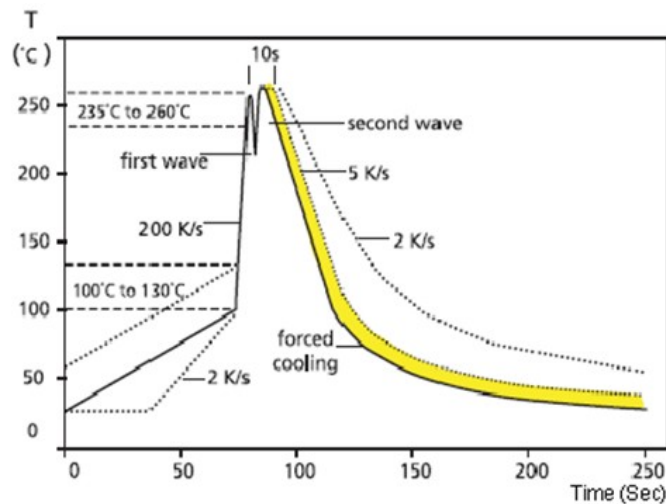

12. Packing of Surface Mount Resistors

12.1 Dimension of Embossed Taping: (Unit: mm)

Type	A ±0.2	B ±0.2	C ±0.05	$\Phi D_{-0}^{+0.1}$	E ±0.1	F ±0.05	G ±0.1	W ±0.2	T ±0.1
10P8/10S8/10T8/10E9	2.00	3.60	2.00	1.50	1.75	3.50	4.00	8.00	0.85

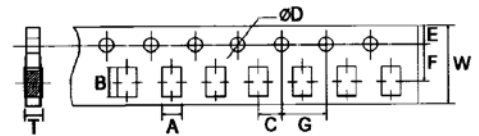

12.2 Dimension of Embossed Taping: (Unit: mm)

Type	A ±0.2	B ±0.2	C ±0.05	$\Phi D_{-0}^{+0.1}$	$\Phi D1_{-0}^{+0.25}$	E ±0.1	F ±0.05	G ±0.1	W ±0.2	T ±0.1
8R06/8S06	3.40	6.60	2.00	1.50	1.50	1.75	5.50	4.00	12.00	1.00

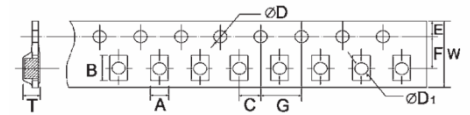

12.3 Dimension of Reel : (Unit: mm)

TYPE	Qty/Reel	A ± 0.5	B ± 0.5	C ± 0.5	D ± 1.0	M ± 2.0	W ± 1.0
10P8	5,000PCS	2.0	13.0	21.0	60.0	178.0	10.0
10S8	5,000PCS	2.0	13.0	21.0	60.0	178.0	10.0
10T8	5,000PCS	2.0	13.0	21.0	60.0	178.0	10.0
10E9	5,000PCS	2.0	13.0	21.0	60.0	178.0	10.0
8R06	4,000PCS	2.0	13.0	21.0	60.0	178.0	13.8
8S06	4,000PCS	2.0	13.0	21.0	60.0	178.0	13.8

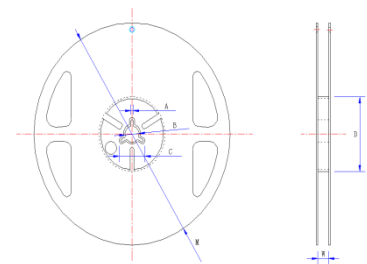

13. Note

13.1. UNI-ROYAL recommend products store in warehouse with temperature between 15 to 35°C under humidity between 25 to 75%RH.

Even under storage conditions recommended above, solder ability of products will be degraded stored over 1 year old.

13.2. Cartons must be placed in correct direction which indicated on carton, otherwise the reel or wire will be deformed.

13.3. Storage conditions as below are inappropriate:

- Stored in high electrostatic environment
- Stored in direct sunshine, rain, snow or condensation.
- Exposed to sea wind or corrosive gases, such as Cl₂, H₂S, NH₃, SO₂, NO₂, Br etc.

14. Record

Version	Description	Page	Date	Amended by	Checked by
1	First issue of this specification	1~8	Mar.20, 2018	Haiyan Chen	Nana Chen
2	Modify characteristic	5~6	Feb.23, 2019	Haiyan Chen	Yuhua Xu
3	Modify the High Temperature Exposure conditions	7	July.29, 2019	Haiyan Chen	Yuhua Xu
4	Modify the reflow curve and add the wave soldering curve	7	Apr.29, 2020	Haiyan Chen	Yuhua Xu
5	Modify the temperature coefficient test conditions	6	Oct.26, 2022	Haiyan Chen	Yuhua Xu

© Uniroyal Electronics Global Co., Ltd. All rights reserved. Specification herein will be changed at any time without prior notice