

DATA SHEET

Product Name Metal Alloy Low Resistance Chip Resistor

Part Name ML Series

Uniroyal Electronics Global Co., Ltd.

88#, Longteng Road, Economic & Technical Development Zone, Kunshan, Jiangsu, China

Tel +86 512 5763 1411 / 22 /33

Email marketing@uni-royal.cn

Manufacture Plant Uniroyal Electronics Industry Co., Ltd.

Aeon Technology Corporation

Royal Electronic Factory (Thailand) Co., Ltd.

Royal Technology (Thailand) Co., Ltd.

1. Scope

- 1.1 This specification for approve relates to the Metal Alloy Low Resistance Chip Resistor manufactured by UNI-ROYAL.
- 1.2 Low Resistance / Low TCR
- 1.3 Excellent long term stability
- 1.4 RoHS compliant and halogen free.
- 1.5 Lead free.
- 1.6 High precision current sensing and voltage division.

2. Part No. System

Part No. includes 14 codes shown as below:

2.1 1st~4th codes: Part name. E.g.: ML06、ML12、ML25、ML28、ML27

2.2 5th~6th codes: Power rating.

Wattage	1	1.5	2	3	4	5
Normal Size	1W	1A	2W	3W	4W	5W

2.3 7th code: Tolerance. E.g.: D=±0.5% F=±1% G=±2% J=±5%

2.4 8th~11th codes: Resistance Value.

2.4.1 If value belongs to standard value of ≥5% series, 8th code would be zero, 9th~10th codes are significant figures of the resistance and 11th code is the power of ten.

2.4.2 If value belongs to standard value of ≤2% series, 8th~10th codes are significant figures of the resistance, and 11th code is the power of ten.

2.4.3 11th codes listed as following:

$$0=10^0 \quad 1=10^1 \quad 2=10^2 \quad 3=10^3 \quad 4=10^4 \quad 5=10^5 \quad 6=10^6 \quad J=10^{-1} \quad K=10^{-2} \quad L=10^{-3} \quad M=10^{-4}$$

$$N=10^{-5} \quad P=10^{-6}$$

2.5 12th~14th codes.

2.5.1 12th code: Packaging Type. E.g.: C=Bulk T=Tape/Reel

2.5.2 13th code: Standard Packing Quantity.

$$4=4000\text{pcs} \quad 5=5000\text{pcs} \quad C=10000\text{pcs} \quad D=20000\text{pcs} \quad E=15000\text{pcs}$$

$$\text{Chip Product: } BD=B/B-20000\text{pcs} \quad TC=T/R-10000\text{pcs}$$

2.5.3 14th code: Special features.

E = Environmental Protection, Lead Free, or Standard type.

3. Ordering Procedure

(Example: ML12 2W ±1% 200mΩ T/R-4000)

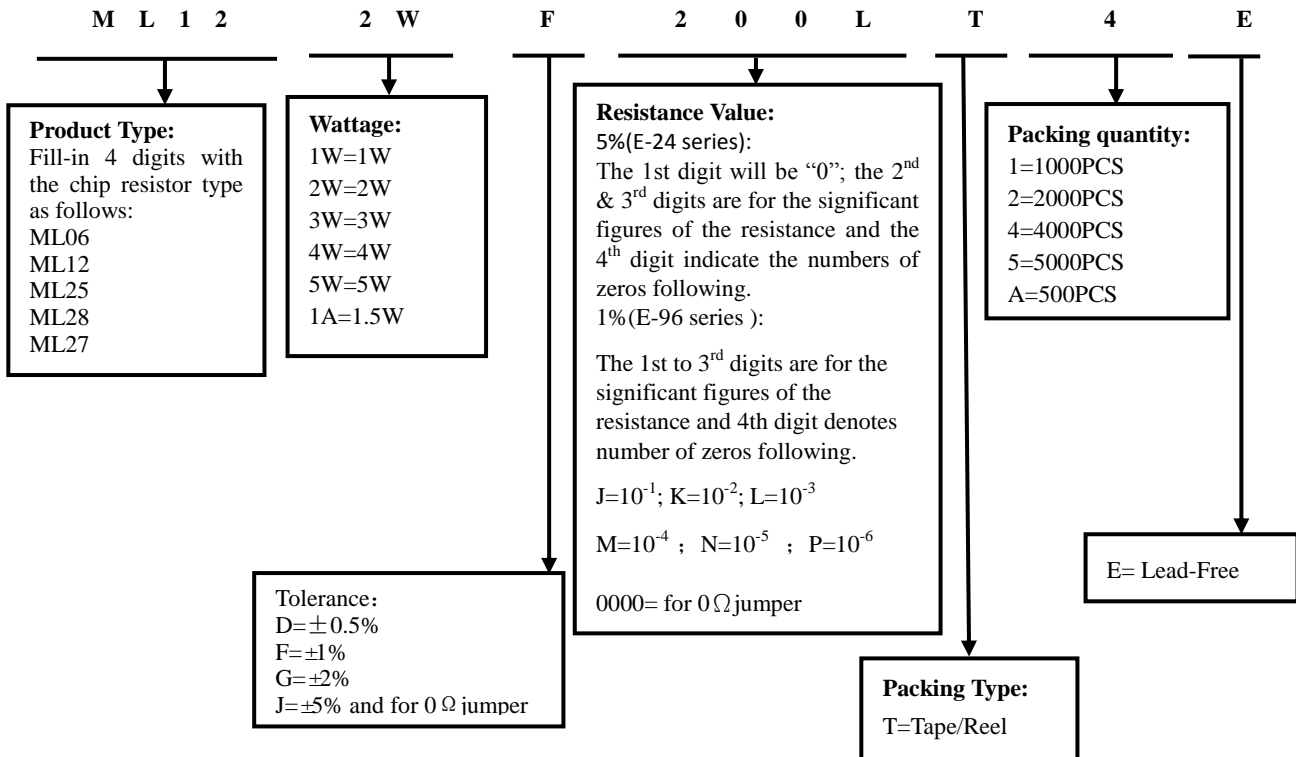

4. Electrical Specifications

5.1 Standard Electrical Specifications

Type	Rating Power	T.C.R. (ppm/°C)	Max. Rating Current (A)	Max. Overload Current (A)	Resistance Range (mΩ)			Operating Temperature Range (°C)
					0.5% (D)	1.0% (F) 2.0% (G) 5.0% (J)		
ML06	1W	$\cong \pm 50$	31.62	70.71	5~50	1~50	-55°C~+170°C	
	1.5W	$\cong \pm 50$	38.72	86.60	5~10	1~10		
ML12	2W	$\cong \pm 75$	63.24	141.42	---	0.5~0.8		
		$\cong \pm 50$	44.72	100.00	3~450	1~450		
	3W		77.45	173.20	---	0.5~0.8		
		$\cong \pm 50$	54.77	122.47	3~100	1~100		
ML25	4W	$\cong \pm 100$	141.42	282.84	---	0.2		
		$\cong \pm 50$	126.49	252.98	---	0.25~3		
ML28	4W	$\cong \pm 50$	31.62	63.24	7~450	4~450		
ML27	3W	$\cong \pm 75$	77.45	173.20	---	0.5		
		$\cong \pm 50$	54.77	122.47	5~60	1~60		
	5W	$\cong \pm 75$	100.00	173.20	---	0.5		
		$\cong \pm 50$	70.71	122.47	5~500	1~500		

Note : The resistance value not shown in the list can be provided by the factory

4.2 Jumper Specifications

Type	Rating Power	Max. Rating Current	Resistance (mΩ)	Operating Temperature Range (°C)
ML06	1W	70.7A	$\cong 0.2$	-55°C~+170°C
ML12	2W	100A		
	3W	122A		

5. Dimension(Unit:mm)

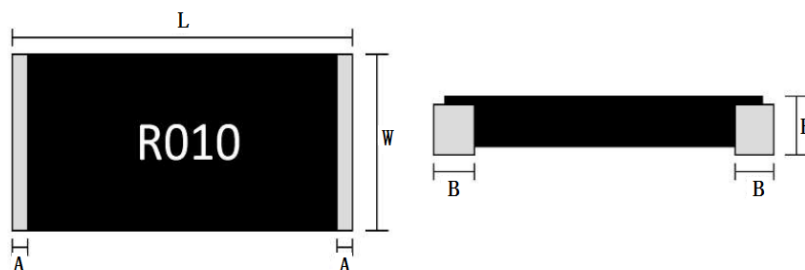

Type	Power Rating	Resistance Range	L	W	H	A	B
ML06 (1206)	1W	1mΩ	3.20±0.25	1.65±0.25	0.82±0.25	0.50±0.30	0.50±0.30
		2mΩ			0.70±0.25		
		3mΩ			0.60±0.25		
		4~20mΩ			0.55±0.25		
		21~50mΩ			0.47±0.25		
	1.5W	1mΩ			0.82±0.25		
		2mΩ			0.70±0.25		
		3mΩ			0.60±0.25		
		4~10mΩ			0.60±0.25		
					0.55±0.25		

ML12 (2512)	2W	0.5mΩ	6.35±0.25	3.05±0.25	0.82±0.25	1.98±0.25	2.00±0.25		
		0.75mΩ			0.70±0.25	1.15±0.25	1.98±0.25		
		0.8mΩ					1.86±0.25		
		1mΩ					2.20±0.25		
		1.5mΩ			0.72±0.25	1.15±0.25	1.40±0.25		
		2~5mΩ					1.15±0.25		
		6mΩ			0.55±0.25	0.75±0.25	1.10±0.25		
		7~10mΩ			0.60±0.25				
		11~75mΩ			0.60±0.25				
		76~100mΩ			0.55±0.25				
		101~135mΩ			0.47±0.25				
		136~200mΩ			0.40±0.25				
		201~450mΩ						0.85±0.25	
ML12 (2512)	3W	0.5mΩ	6.35±0.25	3.05±0.25	0.82±0.25			1.98±0.25	2.00±0.25
		0.75mΩ			0.70±0.25			1.15±0.25	1.98±0.25
		0.8mΩ							1.86±0.25
		1mΩ							2.20±0.25
		1.5mΩ			0.72±0.25			1.15±0.25	1.40±0.25
		2~5mΩ							1.15±0.25
		6mΩ			0.55±0.25	0.75±0.25	1.10±0.25		
		7~10mΩ			0.60±0.25				
		11~75mΩ			0.60±0.25				
		76~100mΩ			0.55±0.25				
ML25 (2725)	4W	0.2mΩ	6.90±0.25	6.35±0.25	1.10±0.25			1.20±0.25	2.15±0.25
		0.25mΩ			0.95±0.25				2.29±0.25
		0.3mΩ							1.97±0.25
		0.35mΩ							1.71±0.25
		0.4mΩ							1.44±0.25
		0.5mΩ							2.08±0.25
		0.6mΩ	0.85±0.25			1.78±0.25			
		0.8mΩ			1.30±0.25				
		1mΩ			1.80±0.25				
		1.5~1.6mΩ	6.80±0.25		1.15±0.25	1.50±0.25			
		2~3mΩ				0.65±0.25			
					0.55±0.25				
ML28 (2728)	4W	4~450mΩ	6.60±0.25	6.70±0.25	0.58±0.25	0.40±0.25	1.05±0.25		
ML27 (4527)	3W	0.5mΩ	11.30±0.50	6.60±0.50	0.77±0.25	0.90±0.25	3.00±0.25		
		1mΩ			0.65±0.25		2.00±0.25		
		1.5~20mΩ					0.55±0.25		
		21~60mΩ							
	5W	0.5mΩ			0.65±0.25	0.80±0.25	3.00±0.25		
		1mΩ				0.68±0.25	2.00±0.25		
		1.5~20mΩ							
		21~500mΩ				0.58±0.25			

Jumper Dimension

Unit:mm							
Type	Power Rating	Resistance Range	L	W	H	A	B
ML06 (1206)	1W	$\cong 0.2m\Omega$	3.20 ± 0.25	1.65 ± 0.25	0.65 ± 0.25	0.50 ± 0.30	0.50 ± 0.30
ML12 (2512)	2W 3W	$\cong 0.2m\Omega$	6.35 ± 0.25	3.05 ± 0.25	0.65 ± 0.25	1.15 ± 0.25	1.10 ± 0.25

6. Marking

6.1 Normally, All the products marking are 4 digits.

(1) For some products, “R” designates the decimal location in ohms

e.g. $1m\Omega$ the product marking is R001.

$200m\Omega$ the product marking is R200.

(2) For some products, “m” designates the decimal location in milli-ohms

eg : $0.25m\Omega$ the product marking is 0m25.

$0.5m\Omega$ the product marking is 0m50

6.2 0Ω product marking is 0R

6.3 The criteria to distinguishing the mark on the surface of products are that characters can be identified.

7. Structure

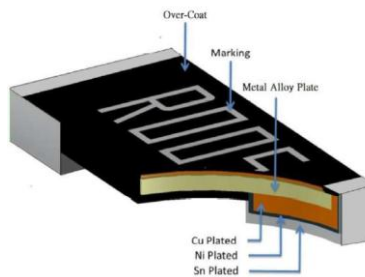

8. Recommend land pattern

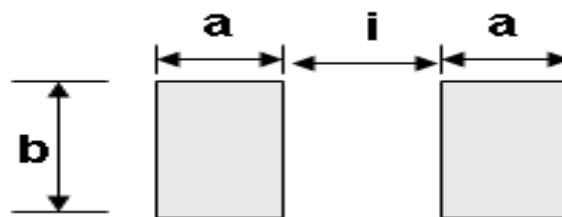

Unit: mm				
Type	Resistance Range	a	b	i
ML06	Jumper : $\cong 0.2m\Omega$	1.46	2.15	1.68
	$1m\Omega \sim 50m\Omega$	1.46	2.15	1.68
ML12	Jumper : $\cong 0.2m\Omega$	2.30	3.68	3.15
	$0.5m\Omega \sim 1m\Omega$	3.24	3.68	1.27
	$1.5m\Omega$	3.20	3.68	1.35
	$2m\Omega \sim 5m\Omega$	2.60	3.68	2.55
	$6m\Omega \sim 200m\Omega$	2.30	3.68	3.15
	$201m\Omega \sim 450m\Omega$	2.05	3.68	3.65
ML25	$0.2m\Omega \sim 0.35m\Omega$	2.90	6.7	1.28
	$0.4m\Omega \sim 0.8m\Omega$	3.25	6.85	1.70
	$1m\Omega \sim 3m\Omega$	2.75	6.85	2.70
ML28	$4m\Omega \sim 450m\Omega$	2.05	7.20	3.90
ML27	$0.5m\Omega \sim 1.5m\Omega$	4.50	8.74	4.50
	$2.0m\Omega \sim 100m\Omega$	3.50	8.74	6.50
	$101m\Omega \sim 500m\Omega$	3.50	8.74	6.50

9. Derating Curve

Resistors shall have a power rating based on continuous load operation at an ambient temperature of 70 °C. For temperature in excess of 70 °C , The load shall be derate as shown in figure 1.

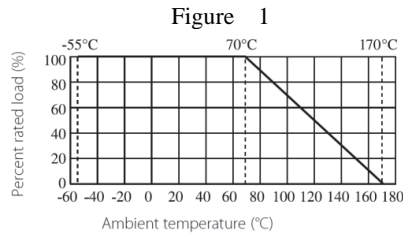

The following equation may be used to determine the DC (Direct Current) or AC (Alternating Current) (RMS, root mean square value) of normal rated power. However, if the result value exceeds the highest current of regulated standards, the highest normal rated power is to be used

$$I = \sqrt{P/R}$$

I = Rating current (A)
 P = Rating Power (W)
 R = Resistance(Ω)

10. Performance Specification

Test Item	Test Methods (GB/T 5729, JIS-C-5201, IEC 60115-1)	Requirements
Temperature Coefficient	At 25°C /+150 °C, 25°C is the reference temperature	List by specification
Short-time overload	4.13 The number of rated power are as follows : ML06: 5 times of rated power; ML12-2W: 5 times of rated power; ML12-3W: 5 times of rated power;*(Note) ML25: 4 times of rated power; ML28: 4 times of rated power; ML27-3W: 5 times of rated power; ML27-5W: 3 times of rated power; for 5 seconds	ML27: ΔR≤±2.0% The others:ΔR≤±0.5%
Load Life	4.25.1 Permanent Resistance change after 1000 hours operating at rated working current or Max .Working Current whichever less with duty cycle of 1.5hours “ON” , 0.5 hour “OFF” at 70±2 °C ambient.	ML27: ΔR≤±2.0% The others:R≤±1.0%
High Temperature Exposure	MIL-STD-202 108A Exposed to a temperature of 155±2 °C for 1000H.	ML27: ΔR≤±2.0% The others:R≤±1.0%
Biased Humidity	MIL-STD-202 Method 103 1000 hours 85 °C/85%RH. Note: Specified conditions:10% of operating power. Measurement at 24±4 hours after test conclusion.	ΔR≤±0.5%
Rapid change of temperature	4.19. 30 min at -55 °C and 30 min at 155 °C; 100 cycles	ΔR≤±0.5%
Terminal bending	4.33. 2mm , 10Sec	ΔR≤±0.5%
Resistance to Solder Heat	4.18 Dip the resister into a temperature of 260±5 °C and hold it for a 10±1 seconds.	ΔR≤±0.5%
Solderability	4.17 The area covered with a new, smooth, clean, shiny and continuous surface free from concentrated pinholes. Temperature of solder: 245±3 °C; Dwell time in solder: 2~3seconds.	>95% Coverage
Dielectric Withstanding Voltage	4.7 Applied 500 VAC for 1 minute , and Limit surge current 50 mA (max.)	No short or burned on the appearance
Terminal Strength	4.16 5N , 10 seconds	No broken

***Note: This test is a destructive experiment. The top protective layer is prone to damage and peculiar smell during, in the 50mR~100mR resistance test. The resistance change rate can meets the specifications.**

For Jumper

Test Item	Test Methods (GB/T 5729, JIS-C-5201, IEC 60115-1)	Requirements
Short Time Overload	4.13 Permanent resistance change after the application of a potential of 4 times power rate for 5 seconds	$\cong 0.2m\Omega$
Rapid change of temperature	4.19 30 min at -55 °C and 30 min at 155 °C; 100 cycles	$\cong 0.2m\Omega$
High Temperature Exposure	MIL-STD-202 108A Exposed to a temperature of 155±2 °C for 1000H.	$\cong 0.2m\Omega$
Biased Humidity	MIL-STD-202 Method 103 1000 hours 85 °C/85%RH. Note: Specified conditions:10% of operating power . Measurement at 24±4 hours after test conclusion.	$\cong 0.2m\Omega$
Load Life	4.25 Permanent Resistance change after 1000 hours operating at rated working current or Max .Working Current whichever less with duty cycle of 1.5hours “ON” , 0.5 hour “OFF” at 70±2 °C ambient.	$\cong 0.2m\Omega$
Solderability	4.17 The area covered with a new, smooth, clean, shiny and continuous surface free from concentrated pinholes. Temperature of solder : 245±3 °C; Dwell time in solder: 2~3 seconds.	>95% coverage

11. Soldering Condition

(This is for recommendation, please customer perform adjustment according to actual application)

11.1 Recommend Reflow Soldering Profile: (solder : Sn96.5 / Ag3 / Cu0.5)

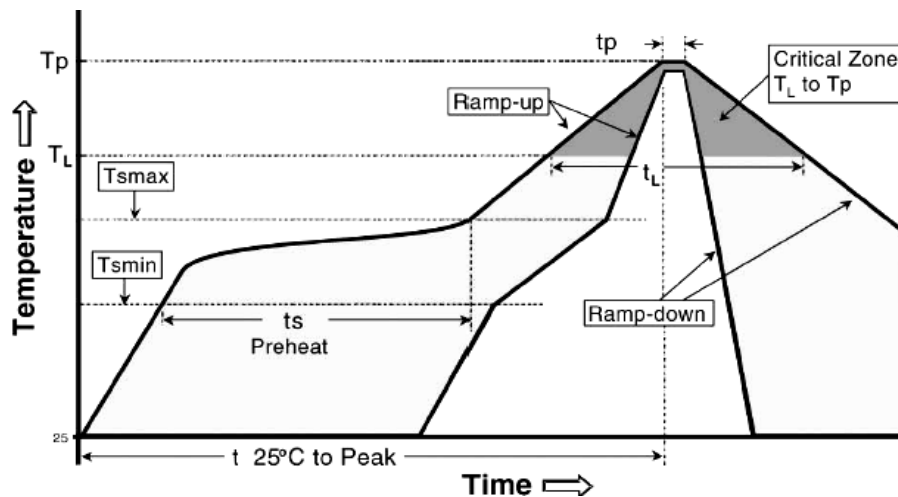

Profile Feature	Lead (Pb)-Free solder
Preheat: Temperature Min (T_{smin}) Temperature Max (T_{smax}) Time (T_{smin} to T_{smax}) (t_s)	150°C 200°C 60 -120seconds
Average ramp-up rate: (T_{smax} to T_p)	3°C/ second max.
Time maintained above : Temperature (T_L) Time (t_L)	217°C 60-150 seconds
Peak Temperature (T_p)	260°C
Time within $+0^{\circ}C$ to $-5^{\circ}C$ of actual peak Temperature (t_p) ²	10 seconds
Ramp-down Rate	6°C/second max.
Time 25°C to Peak Temperature	8minutes max.

Allowed Re-flow times : 2 times

Remark : To avoid discoloration phenomena of chip on terminal electrodes, please use N₂ Re-flow furnace .

11.2 Recommend Wave Soldering Profile :

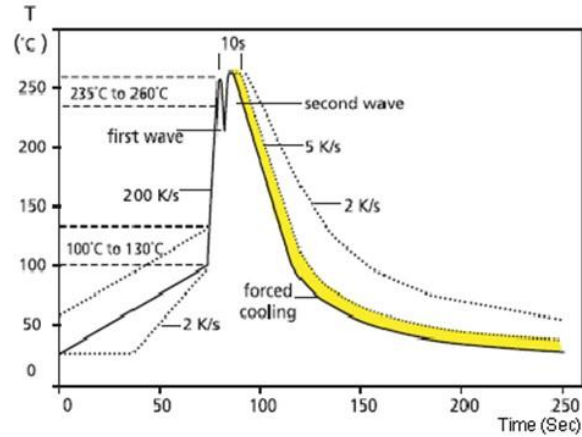

12. Packing of Surface Mount Resistors

12.1 Embossed Dimensions:(Unit: mm)

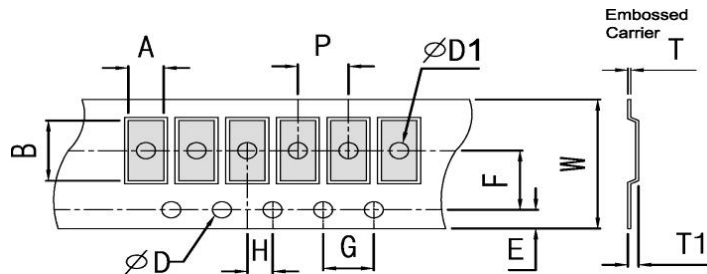

Type	Resistance Range	W	P	E	F	ϕD	$\phi D1$	G	H	A	B	T1	T
ML06	1m Ω	8.0 \pm 0.30	4.0 \pm 0.10	1.75 \pm 0.10	3.5 \pm 0.10	1.50 $^{+0.1}_{-0}$	1.0 \pm 0.10	4.0 \pm 0.10	2.0 \pm 0.10	2.03 \pm 0.10	3.55 \pm 0.10	1.10 \pm 0.10	0.20 \pm 0.05
ML06	2~50m Ω	8.0 \pm 0.30	4.0 \pm 0.10	1.75 \pm 0.10	3.5 \pm 0.10	1.50 $^{+0.1}_{-0}$	1.0 \pm 0.10	4.0 \pm 0.10	2.0 \pm 0.10	2.03 \pm 0.10	3.55 \pm 0.10	0.85 \pm 0.10	0.20 \pm 0.05
ML12	0.5 m Ω /1 m Ω	12.0 \pm 0.30	4.0 \pm 0.10	1.75 \pm 0.10	5.5 \pm 0.10	1.50 $^{+0.1}_{-0}$	1.55 \pm 0.10	4.0 \pm 0.10	2.0 \pm 0.10	3.50 \pm 0.10	6.75 \pm 0.10	1.10 \pm 0.10	0.20 \pm 0.05
ML12	0.75m Ω /0.8m Ω 1.5~450m Ω	12.0 \pm 0.30	4.0 \pm 0.10	1.75 \pm 0.10	5.5 \pm 0.10	1.50 $^{+0.1}_{-0}$	1.55 \pm 0.10	4.0 \pm 0.10	2.0 \pm 0.10	3.50 \pm 0.10	6.75 \pm 0.10	0.90 \pm 0.10	0.20 \pm 0.05
ML25	0.2~0.8m Ω	12.0 \pm 0.30	8.0 \pm 0.10	1.75 \pm 0.10	5.5 \pm 0.10	1.50 $^{+0.1}_{-0}$	1.55 \pm 0.10	4.0 \pm 0.10	2.0 \pm 0.10	6.81 \pm 0.10	7.16 \pm 0.10	1.30 \pm 0.10	0.25 \pm 0.05
ML25	1~3m Ω	12.0 \pm 0.30	8.0 \pm 0.10	1.75 \pm 0.10	5.5 \pm 0.10	1.50 $^{+0.1}_{-0}$	1.55 \pm 0.10	4.0 \pm 0.10	2.0 \pm 0.10	6.81 \pm 0.10	7.16 \pm 0.10	1.05 \pm 0.10	0.25 \pm 0.05
ML28	4~450m Ω	12.0 \pm 0.30	8.0 \pm 0.10	1.75 \pm 0.10	5.5 \pm 0.10	1.50 $^{+0.1}_{-0}$	1.55 \pm 0.10	4.0 \pm 0.10	2.0 \pm 0.10	7.10 \pm 0.10	7.05 \pm 0.10	0.95 \pm 0.10	0.20 \pm 0.05
ML27	0.5~500m Ω	24.0 \pm 0.30	12.0 \pm 0.10	1.75 \pm 0.10	11.5 \pm 0.10	1.50 $^{+0.1}_{-0}$	1.50 \pm 0.10	4.0 \pm 0.10	2.0 \pm 0.10	7.38 \pm 0.10	12.0 \pm 0.10	1.05 \pm 0.10	0.30 \pm 0.10

12.2 Dimension of Reel : (Unit: mm)

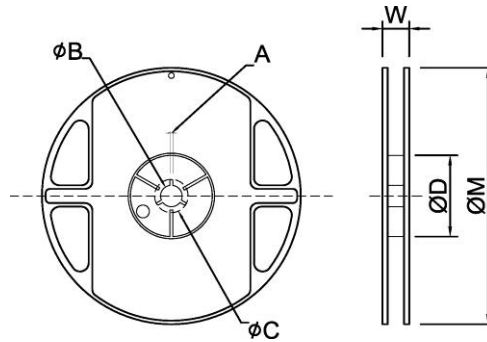

Type	Taping	Qty/Reel	A	φ B	φ C	φ D	W	φ M
ML06	Embossed	5,000pcs	2.0±0.5	13.2±0.5	17.7±0.5	60.0±0.5	12.0±0.5	178±1.0
ML06-1mΩ	Embossed	4,000pcs	2.0±0.5	13.2±0.5	17.7±0.5	60.0±0.5	12.0±0.5	178±1.0
ML12	Embossed	4,000pcs	2.5±0.5	13.5±0.5	17.7±0.5	60.0±0.5	16.2±0.5	178±1.0
ML25 0.2≤R≤0.8mΩ	Embossed	1,000pcs	2.5±0.5	13.5±0.5	17.7±0.5	60.0±0.5	16.2±0.5	178±1.0
ML25 R≥1mΩ	Embossed	2,000pcs	2.5±0.5	13.5±0.5	17.7±0.5	60.0±0.5	16.2±0.5	178±1.0
ML28	Embossed	2,000pcs 1,000pcs	2.5±0.5	13.5±0.5	17.7±0.5	60.0±0.5	16.2±0.5	178±1.0
ML27	Embossed	1,000pcs 500pcs	2.0±0.5	13.2±0.5	17.7±0.5	60.0±0.5	24.4±2.0	178±1.0

13. Note

- 13.1 UNI-ROYAL recommend products store in warehouse with temperature between 15 to 35 °C under humidity between 25 to 75%RH.
Even under UNI-ROYAL recommended storage condition, solderability of products over 1 year old. (Put condition for each product) may be degraded.
- 13.2 Store / transport cartons in the correct direction, which is indicated on a carton as a symbol.
Otherwise bent leads may occur due to excessive stress applied when dropping of a carton.
- 13.3 Product performance and soldered connections may deteriorate if the products are stored in the following places:
- Storage in high Electrostatic.
 - Storage in direct sunshine、rain and snow or condensation.
 - Where the products are exposed to sea winds or corrosive gases, including Cl₂, H₂S, NH₃, SO₂, NO₂, Br, etc.

14. Record

Version	Description	Page	Date	Amended by	Checked by
1	First version	1~10	Apr.26, 2021	Haiyan Chen	Yuhua Xu
2	Extend the resistance range	3~4	Mar.05, 2024	Haiyan Chen	Yuhua Xu

© Uniroyal Electronics Global Co., Ltd. All rights reserved. Specification herein will be changed at any time without prior notice